

FTW 600 X 600 A

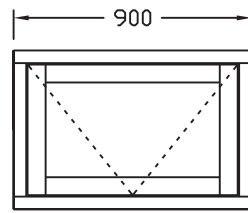

FTW 600 X 900 A

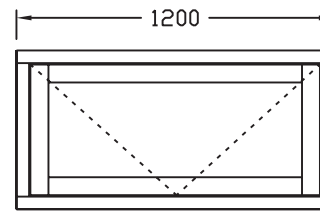

FTW 600 X 1200 A

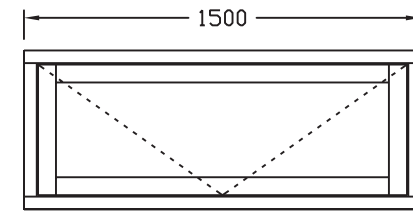

FTW 600 X 1500 A

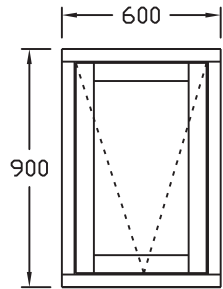

FTW 900 X 600 A

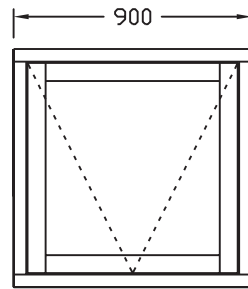

FTW 900 X 900 A

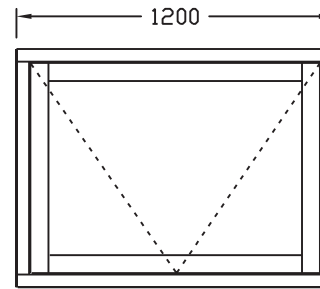

FTW 900 X 1200 A

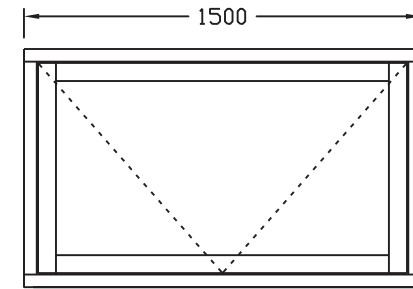

FTW 900 X 1500 A

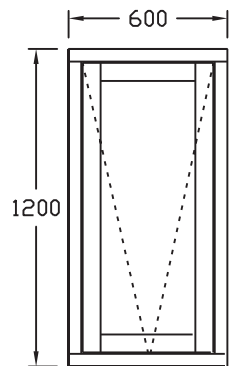

FTW 1200 X 600 A

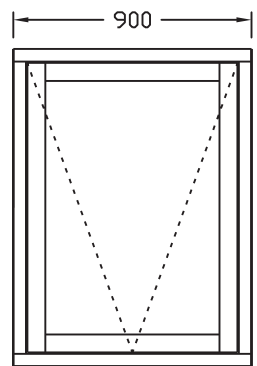

FTW 1200 X 900 A

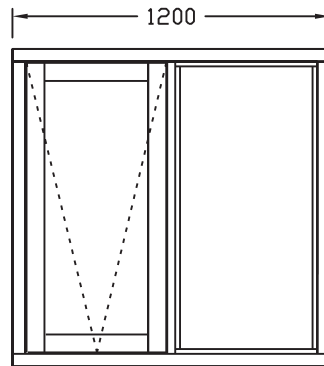

FTW 1200 X 1200 A

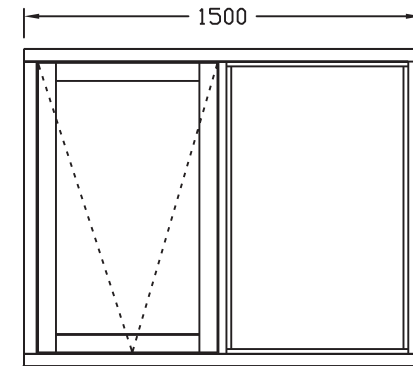

FTW 1200 X 1500 A

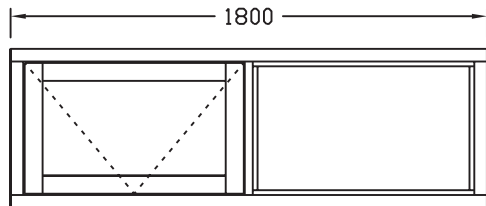

FTW 600 X 1800 A

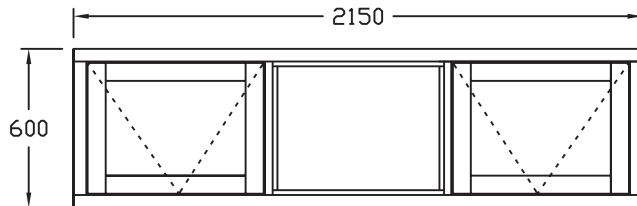

FTW 600 X 2150 A

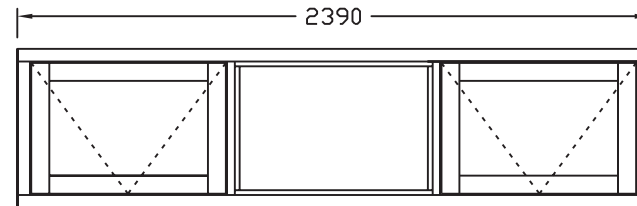

FTW 600 X 2390 A

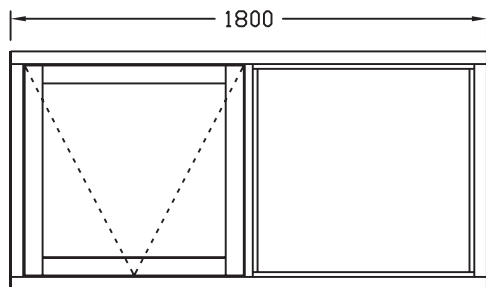

FTW 900 X 1800 A

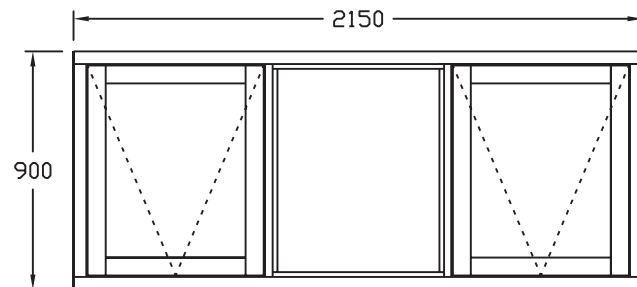

FTW 900 X 2150 A

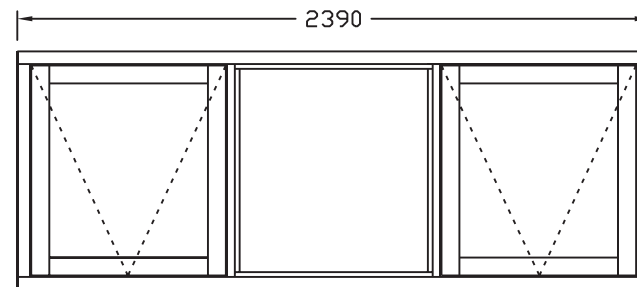

FTW 900 X 2390 A

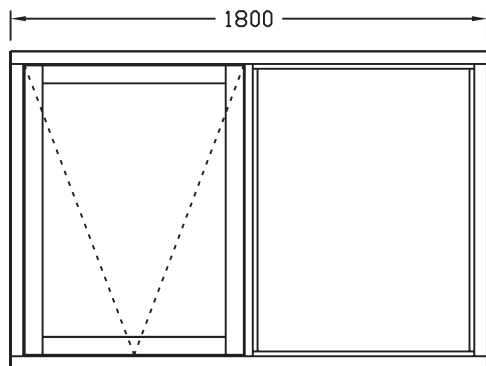

FTW 1200 X 1800 A

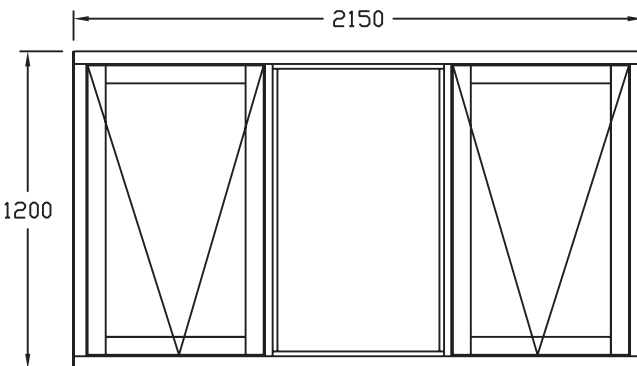

FTW 1200 X 2150 A

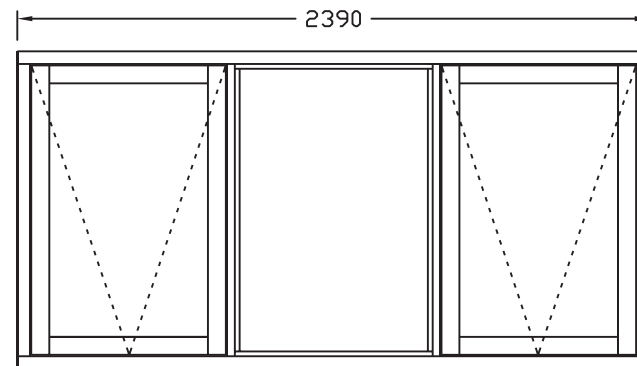

FTW 1200 X 2390 A

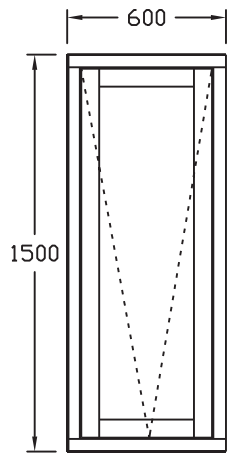

FTW 1500 X 600 A

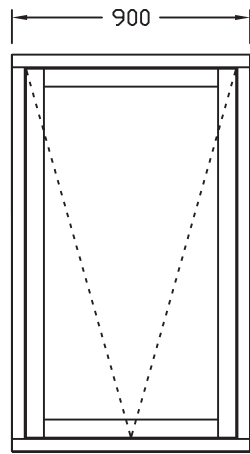

FTW 1500 X 900 A

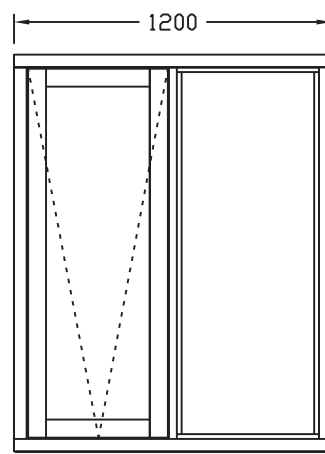

FTW 1500 X 1200 A

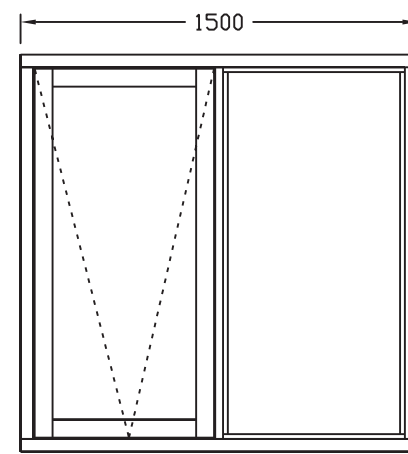

FTW 1500 X 1500 A

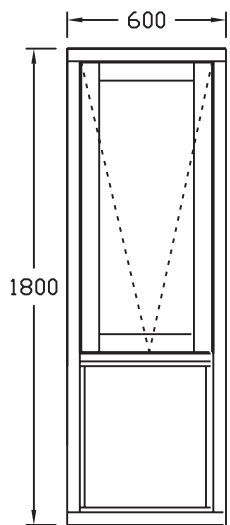

FTW 1800 X 600 A

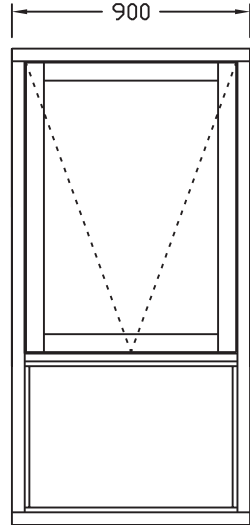

FTW 1800 X 900 A

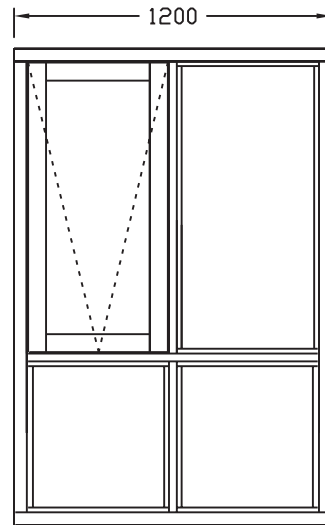

FTW 1800 X 1200 A

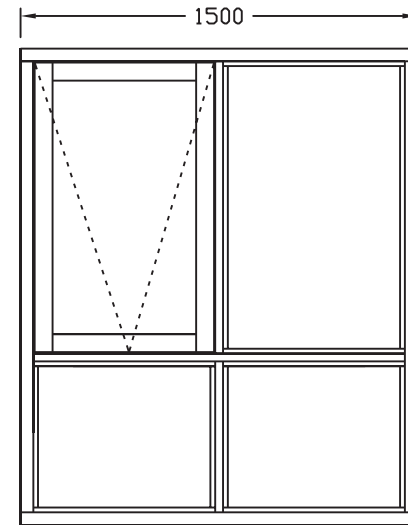

FTW 1800 X 1500 A

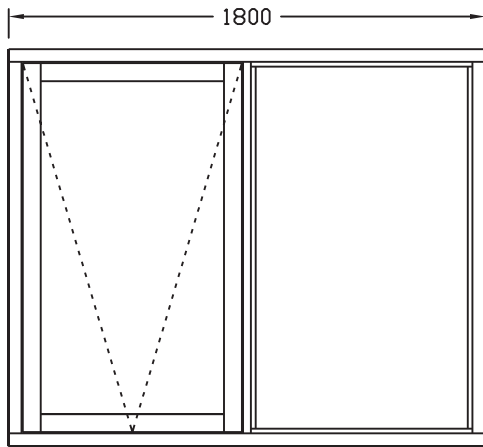

FTW 1500 X 1800 A

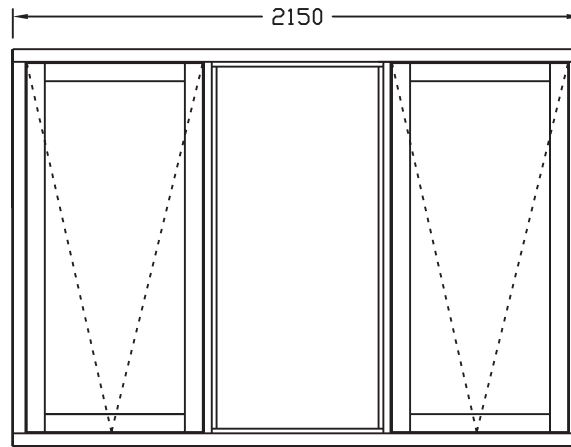

FTW 1500 X 2150 A

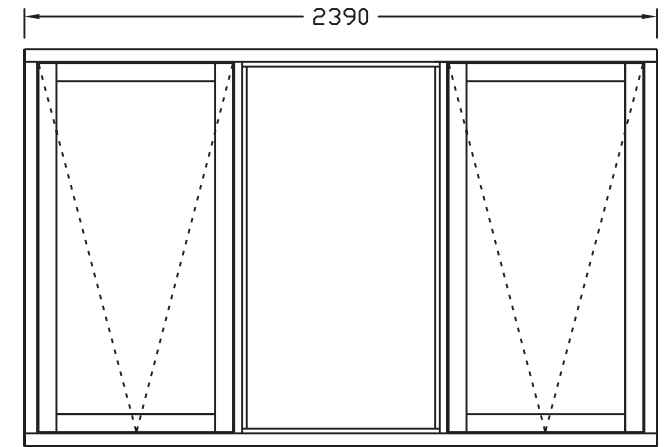

FTW 1500 X 2390 A

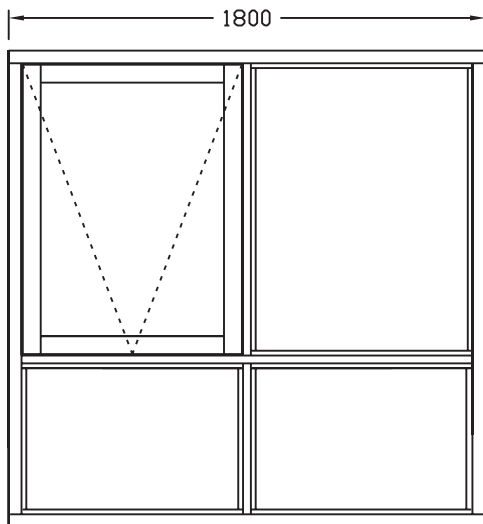

FTW 1800 X 1800 A

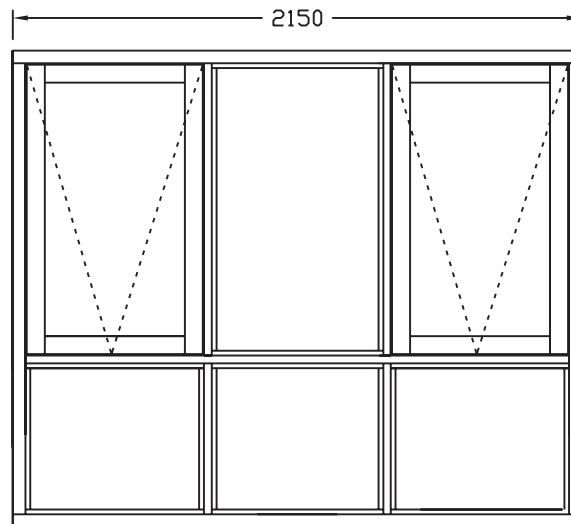

FTW 1800 X 2150 A

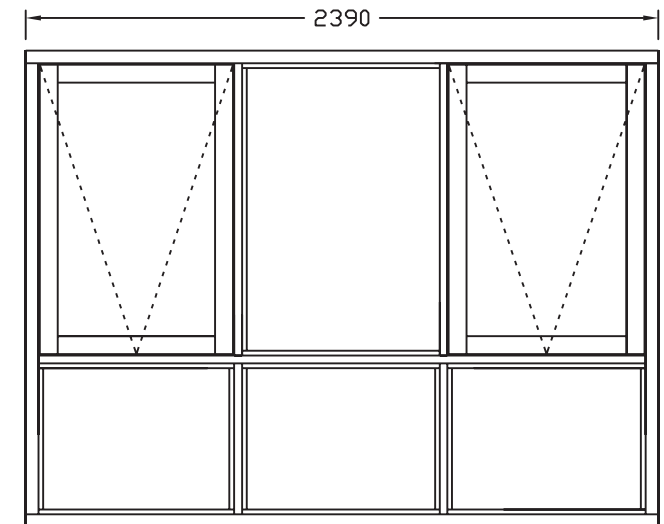

FTW 1800 X 2390 A

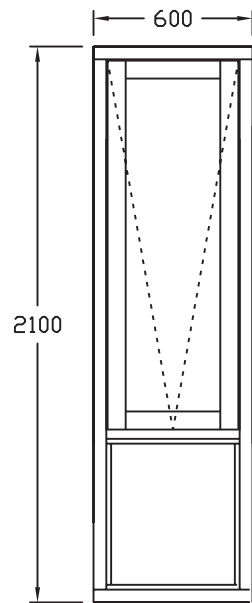

FTW 2100 X 600 A

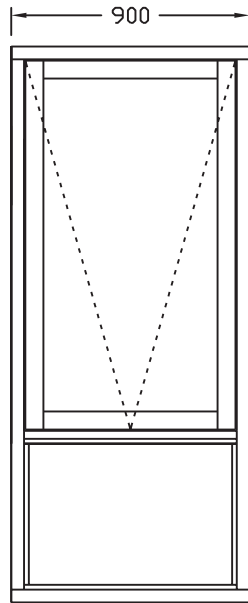

FTW 2100 X 900 A

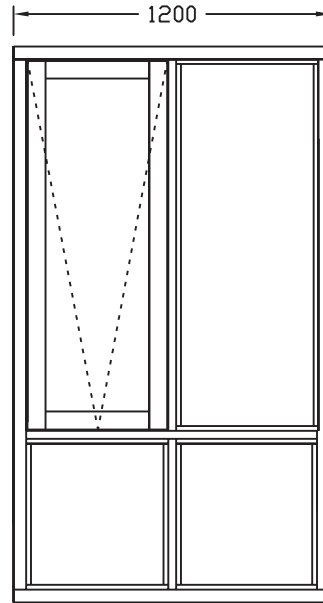

FTW 2100 X 1200 A

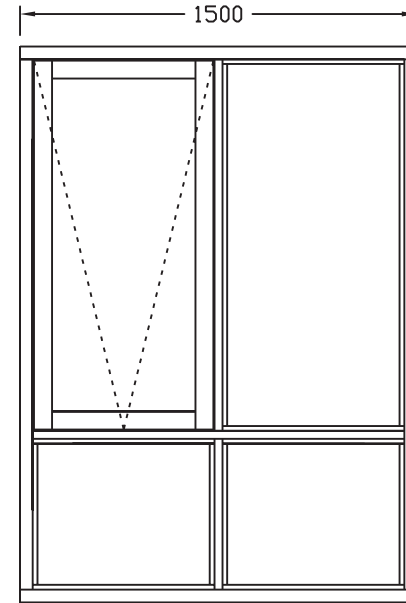

FTW 2100 X 1500 A

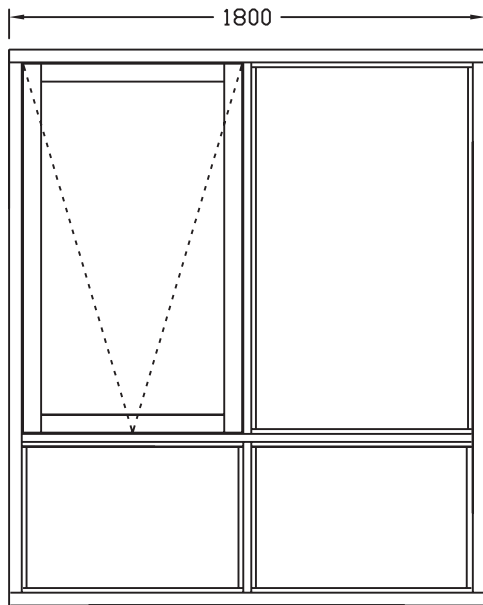

FTW 2100 X 1800 A

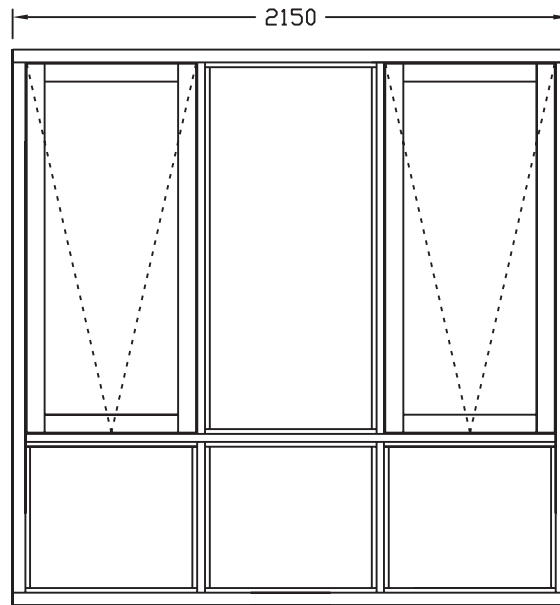

FTW 2100 X 2150 A

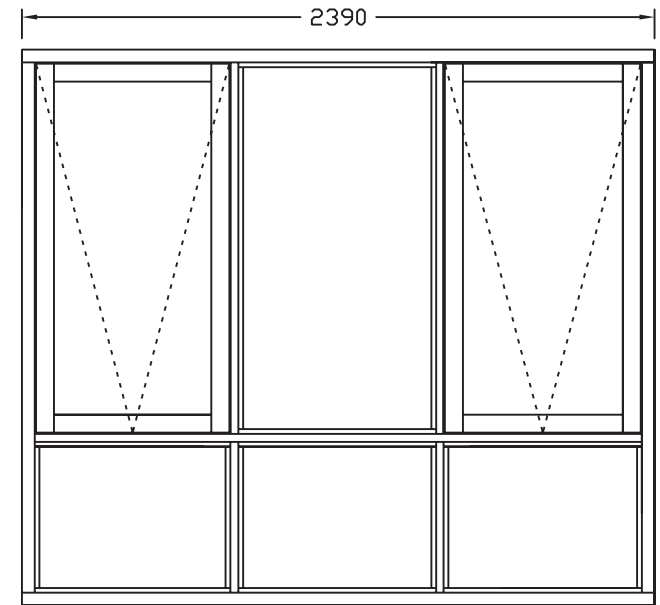

FTW 2100 X 2390 A